



Separation assembly

11500

Product no. **71050017**
GTIN **4018754342235**
Model **11500/2 Trennvorrichtung zu
Abziehvorr.**

Label.

Disconnecter

Product highlights.



For increased safety.

Thoughtfully designed, die-forged and precisely machined, hardened and tempered on state-of-the-art machines - the STAHLWILLE puller range offers numerous products for a wide range of applications. For example, terminal pullers, pullers for ball joints, counter stays or ball joint extractors - always in premium quality.

Technical Drawing.

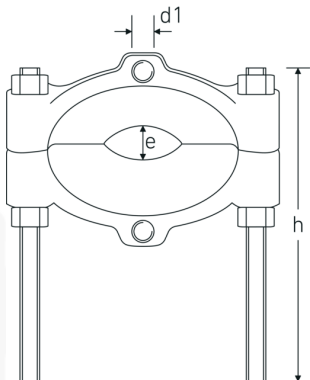

Technical Attributes.

for threads	M10
for model	11501/2
Size	2
Height mm (h)	0 mm
Spreading range (e) min./ max.	12-74 mm

Logistics data.

Depth mm (IFS)	160
Width mm (IFS)	112
Height mm (IFS)	22
Length (packed, mm)	190
Width (packed, mm)	120
Height (packed, mm)	40
Volume (packed, dm3)	0.912 dm3
Product no.	71050017
Weight (gross, kg)	0,952
Weight PAP (kg)	0,052
Weight PVC (kg)	0,000
GTIN	4018754342235
Country of origin AWR	GERMANY
Region of origin	Nordrhein-Westfalen
WEEE/ElektroG	nicht ear-pflichtig
Customs tariff no.	82055980
Packing standard	1
Weight	900 g

Variants.

Product no.	Model no. (ERP)	Description	GTIN
71050016	11500/1 Trennvorrichtung zu Abziehvorr.	Disconnecter	4018754342228
71050017	11500/2 Trennvorrichtung zu Abziehvorr.	Disconnecter	4018754342235
71050018	11500/3 Trennvorrichtung zu Abziehvorr.	Disconnecter	4018754342242
71050019	11500/4 Trennvorrichtung zu Abziehvorr.	Disconnecter	4018754342259

GTIN-Code.



Accessories.



71050102
Puller

Images.

