



Separation assembly

11500

Product no. **71050019**
GTIN **4018754342259**
Model **11500/4 Trennvorrichtung zu
Abziehvorr.**

Label.

Separating fixtur

Features.

- galvanised
- matching No. 11501 of the same size
- for separating and extracting ball bearings, roller bearings, bushings, wheels and other close-fitting parts
- the even tightening of the nuts on the side bolts separates the workpieces
- attach extractor No. 11501; carry out extraction process

Advantages.

For use with extractor device 11051.

For quick separation and extraction of tight fitting parts such as gears, ball bearings and belt pulleys.

Sharp cutting edges make reliable detachment possible in areas where there is insufficient room for extractor hooks.

The separating jaws are clamped by evenly tightening the nuts on the side bolts.

Protects sensitive components thanks to the smooth, even surface of the large contact areas.

Product highlights.



For increased safety.

Thoughtfully designed, die-forged and precisely machined, hardened and tempered on state-of-the-art machines - the STAHLWILLE puller range offers numerous products for a wide range of applications. For example, terminal pullers, pullers for ball joints, counter stays or ball joint extractors - always in premium quality.

Technical Drawing.

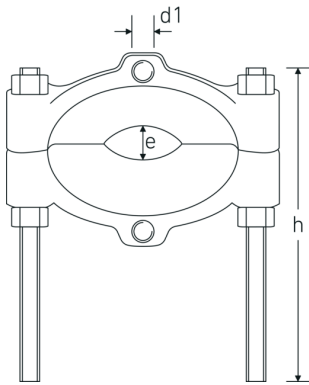

Technical Attributes.

for threads	M18 x 1,5
for model	11501/4
Size	4
Height mm (h)	0 mm
Spreading range (e) min./max.	30-155 mm

Logistics data.

Depth mm (IFS)	300
Width mm (IFS)	215
Height mm (IFS)	35
Length (packed, mm)	300
Width (packed, mm)	215
Height (packed, mm)	35
Volume (packed, dm3)	2.2575 dm3
Product no.	71050019
Weight (gross, kg)	4,688
Weight PAP (kg)	0,012
Weight PVC (kg)	0,000
GTIN	4018754342259
Country of origin AWR	GERMANY
Region of origin	Nordrhein-Westfalen
WEEE/ElektroG	nicht ear-pflichtig
Customs tariff no.	82055980
Packing standard	1
Weight	4700 g

Variants.

Product no.	Model no. (ERP)	Description	GTIN
71050016	11500/1 Trennvorrichtung zu Abziehvorr.	Separating fixtur zu Abziehvorr.	4018754342228

71050017	11500/2 Trennvorrichtung zu Abziehvorr.	Separating fixtur	4018754342235
71050018	11500/3 Trennvorrichtung zu Abziehvorr.	Separating fixtur	4018754342242
71050019	11500/4 Trennvorrichtung zu Abziehvorr.	Separating fixtur	4018754342259

GTIN-Code.



Accessories.



71050104
Puller

Images.





STAHLWILLE Eduard Wille GmbH & Co. KG

Lindenallee 27 · 42349 Wuppertal · Germany · Phone: +49 202 4791-0 · Fax: +49 202 4791-200
info@stahlwille.de · www.stahlwille.com · Copyright by STAHLWILLE Eduard Wille GmbH & Co. KG, Wuppertal
Copyright by STAHLWILLE Eduard Wille GmbH & Co. KG, Wuppertal