



IMPACT socket

2307TX

Product no. **23070050**
GTIN **4018754015245**
Model **2307TX IMP T 50**



Label. IMPACT socket 1/2 " T50 L.40mm

Features.

- for recessed TORX® bolts
- 1/2" internal square drive
- Chrome Alloy Steel, gunmetal finish

Advantages.

1/2" internal square drive.

Product highlights.



Optimized functionality.

All IMPACT sockets have a through cross hole for the connecting pin and a deep groove for the rubber locking ring. The locking pin is not stressed during use.

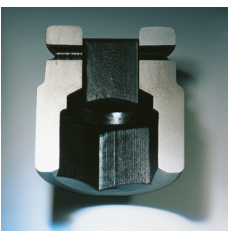

High fitting accuracy.

The high precision fit, achieved through tight tolerances, ensures optimal, backlash-free transmission of forces to the socket.

Technical Drawing.

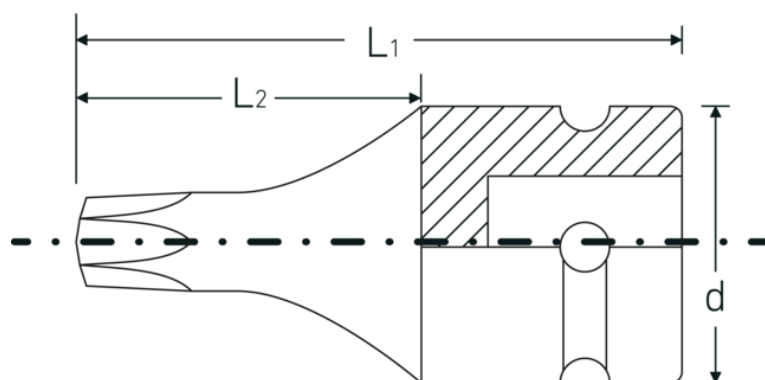

Technical Attributes.

Drive profile	TORX®
TORX® drive profile (mm)	8,8 mm
Internal square drive (inch)	1/2 "
d	25 mm
Size of output profile	T50
L1	40 mm
L2	22 mm

Logistics data.

Depth mm (IFS)	40
Width mm (IFS)	25
Height mm (IFS)	25
Length (packed, mm)	105
Width (packed, mm)	45
Height (packed, mm)	26
Volume (packed, dm3)	0.12285 dm3
Product no.	23070050
Weight (gross, kg)	0,291
Weight PAP (kg)	0,000
Weight PVC (kg)	0,005
GTIN	4018754015245
Country of origin AWR	GERMANY
Region of origin	Nordrhein-Westfalen
WEEE/ElektroG	nicht ear-pflichtig
Customs tariff no.	82042000
Packing standard	5
Weight	57 g

Variants.

Product no.	Model no. (ERP)	Description	GTIN
23070030	2307TX IMP T 30	IMPACT socket 1/2 " T30 L.40mm	4018754015221
23070040	2307TX IMP T 40	IMPACT socket 1/2 " T40 L.40mm	4018754015238
23070045	2307TX IMP T 45	IMPACT socket 1/2 " T45 L.40mm	4018754154012

23070050	2307TX IMP T 50	IMPACT socket 1/2 " T50 L.40mm	4018754015245
23070055	2307TX IMP T 55	IMPACT socket 1/2 " T55 L.40mm	4018754015252
23070060	2307TX IMP T 60	IMPACT socket 1/2 " T60 L.40mm	4018754015269

GTIN-Code.



Accessories.



39022030
Connecting pin



39011940
Rubber rings