



IMPACT sockets 1/2"

50IMP

Product no. **23010018**
GTIN **4018754015030**
Model **50 IMP 18**



Label. IMPACT socket 1/2 " 18mm L.38mm

- Features.**
- with hex
 - 1/2" internal square drive
 - DIN 3129 / ISO 1711-2
 - Chrome Alloy Steel, gunmetal finish

Product highlights.



Powerful and resilient.

The sockets are made from high-quality Chrome Alloy Steel. They are hardened in oil to prevent stress and distortion.



Optimised functionality.

All IMPACT sockets have a through cross hole for the connecting pin and a deep groove for the rubber locking ring. The locking pin is not stressed during use.



High fitting accuracy.

The high fitting accuracy due to tight tolerances guarantees optimum, backlash-free transmission of forces to the socket.

Technical Drawing.

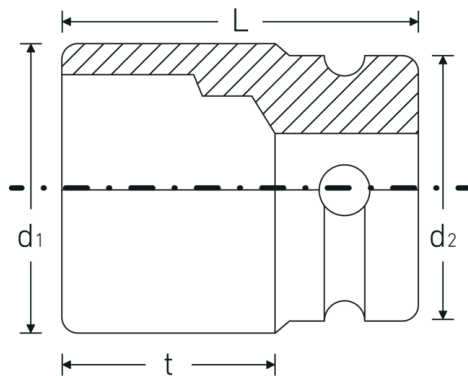

Technical Attributes.

Drive profile	hex
Internal square drive (inch)	1/2 "
d1	27,5 mm
d2	30 mm
DIN	DIN 3129 / ISO 1711-2
Length mm (L)	38 mm
Spanner size [mm]	18 mm
t	22,6 mm

Logistics data.

Depth mm (IFS)	38
Width mm (IFS)	30
Height mm (IFS)	30
Length (packed, mm)	160
Width (packed, mm)	70
Height (packed, mm)	45
Volume (packed, dm ³)	0.504 dm ³
Product no.	23010018
Weight (gross, kg)	1,285
Weight PAP (kg)	0,000
Weight PVC (kg)	0,008
GTIN	4018754015030
Country of origin AWR	GERMANY
Region of origin	Nordrhein-Westfalen
WEEE/ElektroG	nicht ear-pflichtig
Customs tariff no.	82042000
Packing standard	10
Weight	130 g

Variants.

Product no.	Model no. (ERP)	Description	GTIN
23010008	50 IMP 8	IMPACT socket 1/2 " 8mm L.38mm	4018754233731
23010010	50 IMP 10	IMPACT socket 1/2 " 10mm L.38mm	4018754014958
23010011	50 IMP 11	IMPACT socket 1/2 " 11mm L.38mm	4018754014965

23010012	50 IMP 12	IMPACT socket 1/2 " 12mm L.38mm	4018754233748
23010013	50 IMP 13	IMPACT socket 1/2 " 13mm L.38mm	4018754014989
23010014	50 IMP 14	IMPACT socket 1/2 " 14mm L.38mm	4018754014996
23010015	50 IMP 15	IMPACT socket 1/2 " 15mm L.38mm	4018754015009
23010016	50 IMP 16	IMPACT socket 1/2 " 16mm L.38mm	4018754015016
23010017	50 IMP 17	IMPACT socket 1/2 " 17mm L.38mm	4018754015023
23010018	50 IMP 18	IMPACT socket 1/2 " 18mm L.38mm	4018754015030
23010019	50 IMP 19	IMPACT socket 1/2 " 19mm L.40mm	4018754015047
23010021	50 IMP 21	IMPACT socket 1/2 " 21mm L.40mm	4018754015061
23010022	50 IMP 22	IMPACT socket 1/2 " 22mm L.42mm	4018754015078
23010023	50 IMP 23	IMPACT socket 1/2 " 23mm L.40mm	4018754233755
23010024	50 IMP 24	IMPACT socket 1/2 " 24mm L.44mm	4018754015092
23010025	50 IMP 25	IMPACT socket 1/2 " 25mm L.44mm	4018754233762
23010027	50 IMP 27	IMPACT socket 1/2 " 27mm L.45mm	4018754015122
23010030	50 IMP 30	IMPACT socket 1/2 " 30mm L.50mm	4018754233779
23010032	50 IMP 32	IMPACT socket 1/2 " 32mm L.50mm	4018754233786

GTIN-Code.



Accessories.



39022530
Connecting pin



39012440
IMPACT rubber ring

STAHLWILLE Eduard Wille GmbH & Co. KG

Lindenallee 27 · 42349 Wuppertal · Germany · Phone: +49 202 4791-0 · Fax: +49 202 4791-200

info@stahlwille.de · www.stahlwille.com · Copyright by STAHLWILLE Eduard Wille GmbH & Co. KG, Wuppertal

Copyright by STAHLWILLE Eduard Wille GmbH & Co. KG, Wuppertal