

Adapter

447a



Art. nr. 02470016
GTIN 4018754136377
Model 447A 1/4



Betegnelse. Adapter 1/4" Indvendig firkantet 3/8"

Egenskaber.

- SAE AS 954-E
- HPQ®-stål, bruneret
- BEMÆRK! Ændrede indstillingsværdier på momentnøglen <!-- (se note side [170524]) -->

Fordele.

SAE AS 954-E

Teknisk tegning.

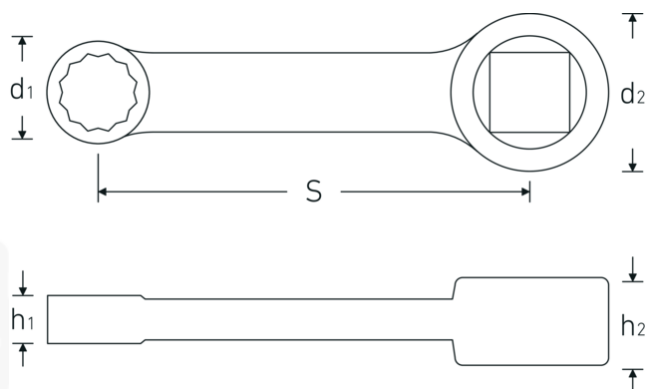

Tekniske egenskaber.

Firkantet fatning [tommer]	3/8 "
d1	10,4 mm
d2	19 mm
Højde mm (h1)	6 mm
Højde mm (h2)	11 mm
S	50,8 mm
Bredde på tværs af flader [tommer]	1/4 "

Logistiske data.

Dybde mm (IFS)	61
Bredde mm (IFS)	15
Højde mm (IFS)	7
Længde (pakket, mm)	71
Bredde (pakket, mm)	25
Højde (pakket, mm)	9
Volumen (pakket, dm3)	0.015975 dm3
Art. nr.	02470016
Vægt (brutto, kg)	0,031
Vægt PAP (kg)	0,000
Vægt PVC (kg)	0,002
GTIN	4018754136377
Oprindelsesland	GERMANY
Oprindelsesregion	Nordrhein-Westfalen
WEEE/ElektroG	nicht ear-pflichtig
Toldtarif nr.	82042000
Standard for pakning	1
Vægt (g)	27 g

Varianter.

Art. nr.	Model nr. (ERP)	Betegnelse	GTIN
02470016	447A 1/4	Adapter 1/4" Indvendig firkantet 3/8"	4018754136377
02470020	447A 5/16	Adapter 5/16" Indvendig firkantet 3/8"	4018754136384
02470024	447A 3/8	Adapter 3/8" Indvendig firkantet 3/8"	4018754136391
02470028	447A 7/16	Adapter 7/16" Indvendig firkantet 3/8"	4018754136407
02470032	447A 1/2	Adapter 1/2" Indvendig firkantet 3/8"	4018754136414
02470034	447A 9/16	Adapter 9/16" Indvendig firkantet 3/8"	4018754136421
02470036	447A 5/8	Adapter 5/8" Indvendig firkantet 3/8"	4018754136438

GTIN-kode.



