

UNIFLEX socket

47



Product no. **02040014**
GTIN **4018754002504**
Model **47 14**



Label. 3/8 " UNIFLEX socket Spanner size 14mm L.48,5mm

Features. • HPQ® heavy-duty steel, chrome-plated

Technologies and features.



High Performance Quality (HPQ®)

Our HPQ® tool is made of wear-resistant high-performance steel, yet is thin-walled and lightweight. It withstands high torques and is ideal for work in confined spaces such as turbines.

Technical Drawing.

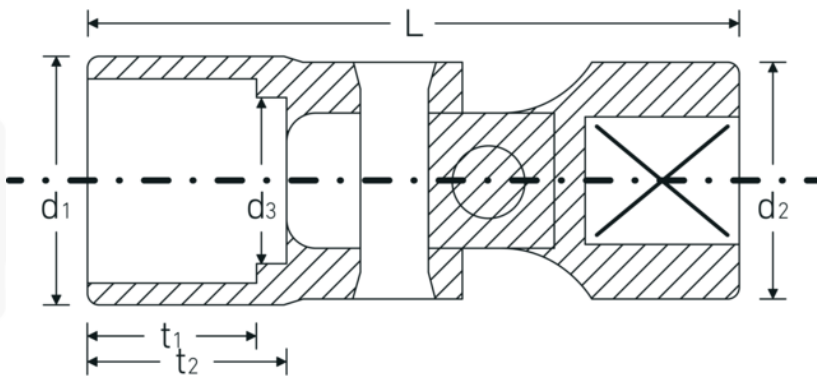

Technical Attributes.

Drive profile	bi-hex AS-Drive®
Internal square drive (inch)	3/8 "
d1	19,4 mm
d2	17,5 mm
d3	13 mm
Length mm (L)	48,5 mm
Width across flats [mm]	14 mm
t1	13 mm
t2	14,5 mm

Logistics data.

Depth mm (IFS)	46
Width mm (IFS)	20
Height mm (IFS)	20
Length (packed, mm)	46
Width (packed, mm)	20
Height (packed, mm)	20
Volume (packed, dm3)	0.0184 dm3
Art. no.	02040014
Weight (gross, kg)	0,055
Weight PAP (kg)	0,000
Weight PVC (kg)	0,002
GTIN	4018754002504
Country of origin	GERMANY
Region of origin	Nordrhein-Westfalen
WEEE/ElektroG	nicht ear-pflichtig
Customs tariff no.	82042000
Packing standard	1
Weight	55 g

Variants.

Art. no.	Model no. (ERP)	Description	GTIN
02040010	47 10	3/8 " UNIFLEX socket Spanner size 10mm L.45,5mm	4018754002467
02040011	47 11	3/8 " UNIFLEX socket Spanner size 11mm L.47,5mm	4018754002474
02040012	47 12	3/8 " UNIFLEX socket Spanner size 12mm L.48mm	4018754002481
02040013	47 13	3/8 " UNIFLEX socket Spanner size 13mm L.48mm	4018754002498
02040014	47 14	3/8 " UNIFLEX socket Spanner size 14mm L.48,5mm	4018754002504
02040015	47 15	3/8 " UNIFLEX socket Spanner size 15mm L.48,5mm	4018754002511
02040016	47 16	3/8 " UNIFLEX socket Spanner size 16mm L.51,5mm	4018754002528
02040017	47 17	3/8 " UNIFLEX socket Spanner size 17mm L.53,5mm	4018754002535

02040018	47 18	3/8 " UNIFLEX socket Spanner size 18mm L.54,5mm	4018754002542
02040019	47 19	3/8 " UNIFLEX socket Spanner size 19mm L.57mm	4018754002559

GTIN-Code.



STAHLWILLE Eduard Wille GmbH & Co. KG

Lindenallee 27 · 42349 Wuppertal · Germany · Phone: +49 202 4791-0 · Fax: +49 202 4791-200
info@stahlwille.de · www.stahlwille.com · Copyright by STAHLWILLE Eduard Wille GmbH & Co. KG, Wuppertal
Copyright by STAHLWILLE Eduard Wille GmbH & Co. KG, Wuppertal