



Sockets 3/8", inch

460a



Product no. **02620016**
GTIN **4018754005086**
Model **460 A 1/4**



Label. 3/8 " Socket Wrench size 1/4" L.32mm

Technical Drawing.

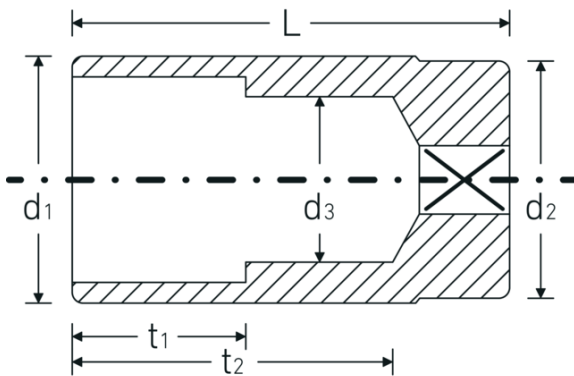

Technical Attributes.

Drive profile	bi-hex AS-Drive®
Internal square drive (inch)	3/8 "
d1	9,9 mm
d2	16,5 mm
d3	5,2 mm
Length mm (L)	32 mm
Wrench size [inch]	1/4 "
t1	7 mm
t2	20,5 mm

Logistics data.

Depth mm (IFS)	32
Width mm (IFS)	17
Height mm (IFS)	17
Length (packed, mm)	90
Width (packed, mm)	50
Height (packed, mm)	17
Volume (packed, dm3)	0.0765 dm3
Product no.	02620016
Weight (gross, kg)	0,105

Weight PAP (kg)	0,000
Weight PVC (kg)	0,005
GTIN	4018754005086
Country of origin	GERMANY
Region of origin	Nordrhein-Westfalen
WEEE/ElektroG	nicht ear-pflichtig
Customs tariff no.	82042000
Packing standard	5
Weight	21 g

Variants.

Product no.	Model no. (ERP)	Description	GTIN
02620016	460 A 1/4	3/8 " Socket Wrench size 1/4" L.32mm	4018754005086
02620020	460 A 5/16	3/8 " Socket Wrench size 5/16" L.32mm	4018754005093
02620024	460 A 3/8	3/8 " Socket Wrench size 3/8" L.38mm	4018754005109
02620028	460 A 7/16	3/8 " Socket Wrench size 7/16" L.38mm	4018754005116
02620032	460 A 1/2	3/8 " Socket Wrench size 1/2" L.44mm	4018754005123

GTIN-Code.

