

Self grip wrench

6564



Product no. **65642250**
GTIN **4018754038145**
Model **6564 Gripzange 250mm**

Label. Self grip wrench L.250mm Head bright nickel-plated Handles glossy nickel-plated

- Features.**
- With forged, half-round jaws
 - With quick release levers and wire cutters
 - Chromium vanadium

Advantages.

With forged, half-round jaws.

Technical Drawing.

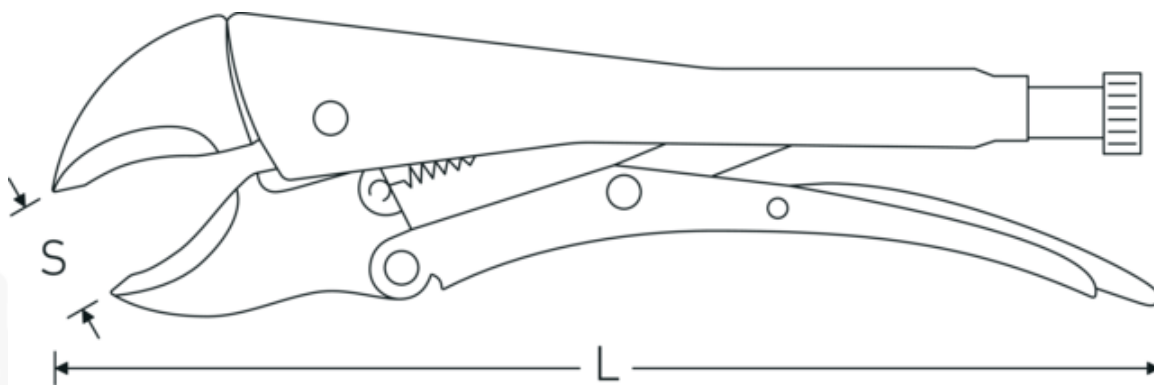

Technical Attributes.

Handles glossy nickel-plated

Logistics data.

Depth mm (IFS) 225

Head	bright nickel-plated	Width mm (IFS)	66
Length mm (L)	250 mm	Height mm (IFS)	22
S	40 mm	Length (packed, mm)	237
		Width (packed, mm)	66
		Height (packed, mm)	22
		Volume (packed, dm3)	0.344124 dm3
		Art. no.	65642250
		Weight (gross, kg)	0,560
		Weight PAP (kg)	0,000
		Weight PVC (kg)	0,002
		GTIN	4018754038145
		Country of origin	GERMANY
		Region of origin	Nordrhein-Westfalen
		WEEE/ElektroG	nicht ear-pflichtig
		Customs tariff no.	82032000
		Packing standard	1
		Weight	550 g

Variants.

Art. no.	Model no. (ERP)	Description	GTIN
65642145	6564 Gripzange 145mm	Self grip wrench L.145mm Head bright nickel-plated Handles glossy nickel-plated	4018754142200
65642175	6564 Gripzange 175mm	Self grip wrench L.175mm Head bright nickel-plated Handles glossy nickel-plated	4018754038138
65642250	6564 Gripzange 250mm	Self grip wrench L.250mm Head bright nickel-plated Handles glossy nickel-plated	4018754038145
65642300	6564 Gripzange 300mm	Self grip wrench L.300mm Head bright nickel-plated Handles glossy nickel-plated	4018754038152

GTIN-Code.





STAHLWILLE Eduard Wille GmbH & Co. KG

Lindenallee 27 · 42349 Wuppertal · Germany · Phone: +49 202 4791-0 · Fax: +49 202 4791-200
info@stahlwille.de · www.stahlwille.com · Copyright by STAHLWILLE Eduard Wille GmbH & Co. KG, Wuppertal
Copyright by STAHLWILLE Eduard Wille GmbH & Co. KG, Wuppertal