



Steckschlüsseinsätze 3/8", metrisch

456

Art.-Nr. 02110018

GTIN 4018754002993

Modell 456 18



Bezeichnung.

3/8 " Steckschlüsseinsatz SW 18mm L.32mm

Eigenschaften.

- Sechskant mit AS-Drive-Profil
- 3/8" Innenvierkant-Antrieb
- HPQ® Hochleistungsstahl, verchromt
- DIN 3124 / ISO 2725-1 / ASME B 107.5M / DIN EN 3709

Technische Zeichnung.

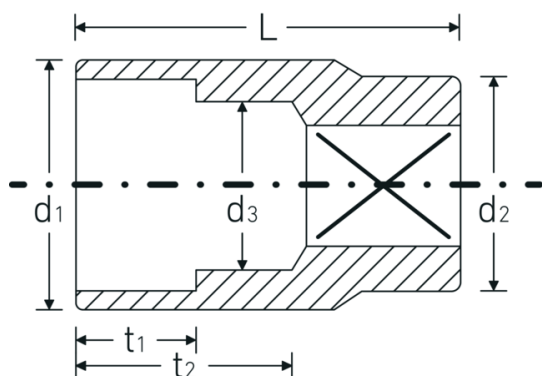

Technische Attribute.

Abtriebsprofil	Sechskant AS-Drive®
Antriebsvierkant innen (Zoll)	3/8 "
d1	24,2 mm
d2	19 mm
d3	17 mm

Logistikdaten.

Tiefe mm (IFS)	28
Breite mm (IFS)	25
Höhe mm (IFS)	25
Länge (verpackt, mm)	126
Breite (verpackt, mm)	51

DIN	DIN 3124 / ISO 2725-1, ASME B 107.5M, DIN EN 3709	Höhe (verpackt, mm)	29
		Volumen (verpackt, dm³)	0.186354 dm ³
		Art.-Nr.	02110018
Länge mm (L)	32 mm	Gewicht (brutto, kg)	0,510
Schlüsselweite [mm]	18 mm	Gewicht PAP (kg)	0,000
t1	13,5 mm	Gewicht PVC (kg)	0,006
t2	19,3 mm	GTIN	4018754002993
		Ursprungsland	GERMANY
		Ursprungsregion	Nordrhein-Westfalen
		WEEE/ElektroG	nicht ear-pflichtig
		Zolltarifnr.	82042000
		Packnorm	10
		Gewicht (g)	42 g

Varianten.

Art.-Nr.	Modell-Nr. (ERP)	Bezeichnung	GTIN
02110007	456 7	3/8 " Steckschlüsseleinsatz SW 7mm L.24mm	4018754002887
02110008	456 8	3/8 " Steckschlüsseleinsatz SW 8mm L.25mm	4018754002894
02110009	456 9	3/8 " Steckschlüsseleinsatz SW 9mm L.25mm	4018754002900
02110010	456 10	3/8 " Steckschlüsseleinsatz SW 10mm L.27mm	4018754002917
02110011	456 11	3/8 " Steckschlüsseleinsatz SW 11mm L.27mm	4018754002924
02110012	456 12	3/8 " Steckschlüsseleinsatz SW 12mm L.28mm	4018754002931
02110013	456 13	3/8 " Steckschlüsseleinsatz SW 13mm L.30mm	4018754002948
02110014	456 14	3/8 " Steckschlüsseleinsatz SW 14mm L.30mm	4018754002955
02110015	456 15	3/8 " Steckschlüsseleinsatz SW 15mm L.31mm	4018754002962
02110016	456 16	3/8 " Steckschlüsseleinsatz SW 16mm L.31mm	4018754002979
02110017	456 17	3/8 " Steckschlüsseleinsatz SW 17mm L.31mm	4018754002986
02110018	456 18	3/8 " Steckschlüsseleinsatz SW 18mm L.32mm	4018754002993
02110019	456 19	3/8 " Steckschlüsseleinsatz SW 19mm L.32mm	4018754003006
02110020	456 20	3/8 " Steckschlüsseleinsatz SW 20mm L.34mm	4018754003013
02110021	456 21	3/8 " Steckschlüsseleinsatz SW 21mm L.34mm	4018754003020
02110022	456 22	3/8 " Steckschlüsseleinsatz SW 22mm L.35mm	4018754003037

GTIN-Code.



STAHLWILLE Eduard Wille GmbH & Co. KG

Lindenallee 27 · 42349 Wuppertal · Deutschland · Tel.: +49 202 4791-0 · Fax: +49 202 4791-200

info@stahlwille.de · www.stahlwille.com

Copyright by STAHLWILLE Eduard Wille GmbH & Co. KG, Wuppertal