

UNIFLEX socket

53



Product no. **03040017**
GTIN **4018754006205**
Model **53 17**



Label. 1/2 " UNIFLEX socket Spanner size 17mm L.70mm

Features. • Chrome-alloy steel, chrome plated

Technologies and features.



High Performance Quality (HPQ®)

Our HPQ® tool is made of wear-resistant high-performance steel, yet is thin-walled and lightweight. It withstands high torques and is ideal for work in confined spaces such as turbines.

Technical Drawing.

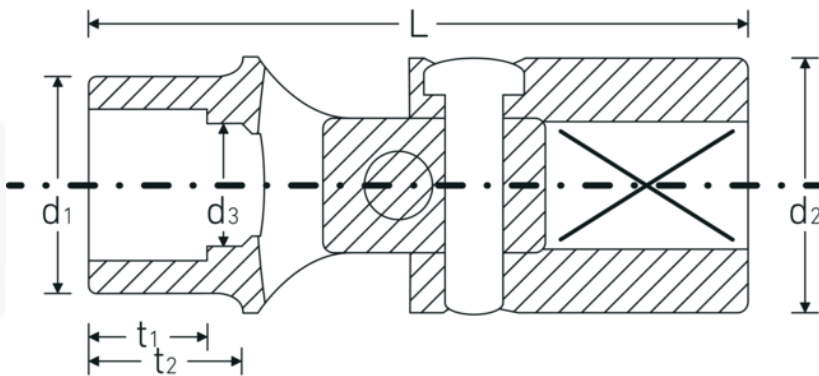

Technical Attributes.

Drive profile	hex AS-Drive®
Internal square drive (inch)	1/2 "
d1	23,5 mm
d2	25 mm
d3	16 mm
Length mm (L)	70 mm
Width across flats [mm]	17 mm
t2	18 mm

Logistics data.

Depth mm (IFS)	71
Width mm (IFS)	25
Height mm (IFS)	25
Length (packed, mm)	75
Width (packed, mm)	26
Height (packed, mm)	26
Volume (packed, dm3)	0.0507 dm3
Art. no.	03040017
Weight (gross, kg)	0,144
Weight PAP (kg)	0,000
Weight PVC (kg)	0,002
GTIN	4018754006205
Country of origin	GERMANY
Region of origin	Nordrhein-Westfalen
WEEE/ElektroG	nicht ear-pflichtig
Customs tariff no.	82042000
Packing standard	1
Weight	141 g

Variants.

Art. no.	Model no. (ERP)	Description	GTIN
03040010	53 10	1/2 " UNIFLEX socket Spanner size 10mm L.70mm	4018754006151
03040013	53 13	1/2 " UNIFLEX socket Spanner size 13mm L.70mm	4018754006175
03040016	53 16	1/2 " UNIFLEX socket Spanner size 16mm L.69mm	4018754006199
03040017	53 17	1/2 " UNIFLEX socket Spanner size 17mm L.70mm	4018754006205
03040018	53 18	1/2 " UNIFLEX socket Spanner size 18mm L.70mm	4018754006212
03040019	53 19	1/2 " UNIFLEX socket Spanner size 19mm L.70mm	4018754006229

GTIN-Code.



STAHLWILLE Eduard Wille GmbH & Co. KG

Lindenallee 27 · 42349 Wuppertal · Germany · Phone: +49 202 4791-0 · Fax: +49 202 4791-200
info@stahlwille.de · www.stahlwille.com · Copyright by STAHLWILLE Eduard Wille GmbH & Co. KG, Wuppertal
Copyright by STAHLWILLE Eduard Wille GmbH & Co. KG, Wuppertal