



Adapter

447a



Product no. 02470016
GTIN 4018754136377
Model 447A 1/4



Label. Adapter 1/4" Internal square 3/8"

- Features.**
- SAE AS 954-E
 - HPQ® heavy-duty steel, gun metal finish
 - Please note: Changed setting values on the torque wrench

Advantages.

SAE AS 954-E.

Technical Drawing.

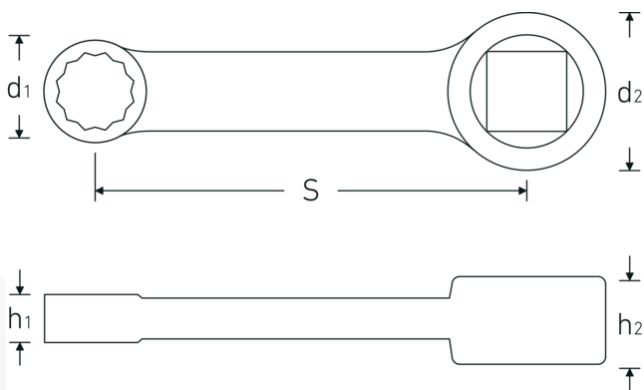

Technical Attributes.

Internal square [inch] 3/8 "

Logistics data.

Depth mm (IFS) 61

d1	10,4 mm	Width mm (IFS)	15
d2	19 mm	Height mm (IFS)	7
Height mm (h1)	6 mm	Length (packed, mm)	71
Height mm (h2)	11 mm	Width (packed, mm)	25
S	50,8 mm	Height (packed, mm)	9
Spanner size [inch]	1/4 "	Volume (packed, dm3)	0.015975 dm3
		Art. no.	02470016
		Weight (gross, kg)	0,031
		Weight PAP (kg)	0,000
		Weight PVC (kg)	0,002
		GTIN	4018754136377
		Country of origin	GERMANY
		Region of origin	Nordrhein-Westfalen
		WEEE/ElektroG	nicht ear-pflichtig
		Customs tariff no.	82042000
		Packing standard	1
		Weight	27 g

Variants.

Art. no.	Model no. (ERP)	Description	GTIN
02470016	447A 1/4	Adapter 1/4" Internal square 3/8"	4018754136377
02470020	447A 5/16	Adapter 5/16" Internal square 3/8"	4018754136384
02470024	447A 3/8	Adapter 3/8" Internal square 3/8"	4018754136391
02470028	447A 7/16	Adapter 7/16" Internal square 3/8"	4018754136407
02470032	447A 1/2	Adapter 1/2" Internal square 3/8"	4018754136414
02470034	447A 9/16	Adapter 9/16" Internal square 3/8"	4018754136421
02470036	447A 5/8	Adapter 5/8" Internal square 3/8"	4018754136438

GTIN-Code.





STAHLWILLE Eduard Wille GmbH & Co. KG

Lindenallee 27 · 42349 Wuppertal · Germany · Phone: +49 202 4791-0 · Fax: +49 202 4791-200
info@stahlwille.de · www.stahlwille.com · Copyright by STAHLWILLE Eduard Wille GmbH & Co. KG, Wuppertal
Copyright by STAHLWILLE Eduard Wille GmbH & Co. KG, Wuppertal