

Adaptor metric

447



Product no. **02181008**
GTIN **4018754139132**
Model **447 8**



Label.

Adapters 8mm Internal square 3/8"

Technical Drawing.

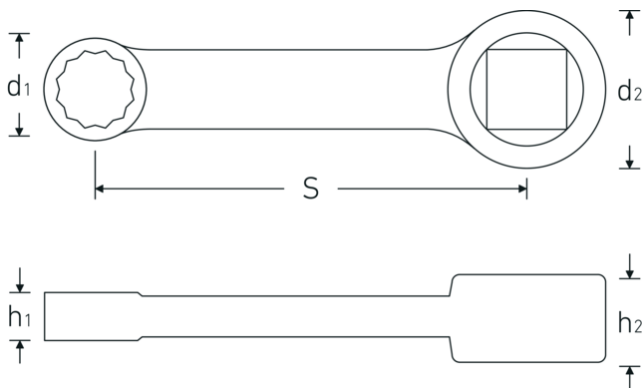

Technical Attributes.

Internal square [inch]	3/8 "
d1	12,4 mm
d2	19 mm
Height mm (h1)	6 mm
Height mm (h2)	11 mm
S	50,8 mm
Width across flats [mm]	8 mm

Logistics data.

Depth mm (IFS)	65
Width mm (IFS)	17
Height mm (IFS)	10
Length (packed, mm)	105
Width (packed, mm)	30
Height (packed, mm)	15
Volume (packed, dm ³)	0.04725 dm ³
Product no.	02181008
Weight (gross, kg)	0,035

Weight PAP (kg)	0,000
Weight PVC (kg)	0,002
GTIN	4018754139132
Country of origin	GERMANY
Region of origin	Nordrhein-Westfalen
WEEE/ElektroG	nicht ear-pflichtig
Customs tariff no.	82042000
Packing standard	1
Weight	30 g

Variants.

Product no.	Model no. (ERP)	Description	GTIN
02181007	447 7	Adapters 7mm Internal square 3/8"	4018754139125
02181008	447 8	Adapters 8mm Internal square 3/8"	4018754139132
02181009	447 9	Adapters 9mm Internal square 3/8"	4018754140992
02181010	447 10	Adapters 10mm Internal square 3/8"	4018754141005
02181013	447 13	Adapters 13mm Internal square 3/8"	4018754141012

GTIN-Code.

