

Doppen 3/8", imperiaal

460a



Artikelnr. 02620016
GTIN 4018754005086
Model 460 A 1/4



Aanwijzing. 3/8 " Dop Maat 1/4" L.32mm

Eigenschappen.

- SAE AS 954, S.B.A.C. AS 40610/40611, ASME B 107.1
- HPQ®-high performance staal, verchroomd

Voordelen.

SAE AS 954-E, S.B.A.C. AS 40610/40611, ASME B 107.1

Technische tekening.

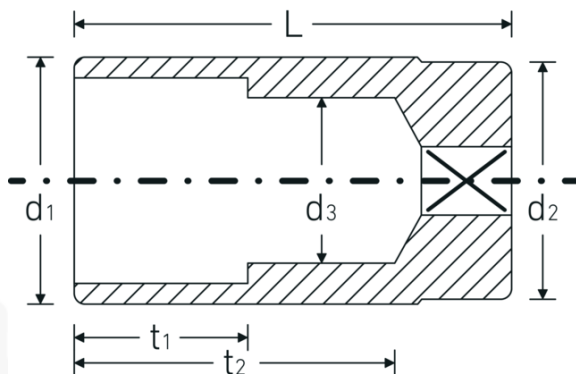

Technische kenmerken.

Uitvoerprofiel Dubbel-zeskant AS-drive

Logistieke gegevens.

Diepte mm (IFS) 32
Breedte mm (IFS) 17

Aandrijving vierkant binnen (inch)	3/8 "
d1	9,9 mm
d2	16,5 mm
d3	5,2 mm
Lengte mm (L)	32 mm
Breedte over vlakken [inch]	1/4 "
t1	7 mm
t2	20,5 mm

Hoogte mm (IFS)	17
Lengte (verpakt, mm)	90
Breedte (verpakt, mm)	50
Hoogte (verpakt, mm)	17
Volume (verpakt, dm3)	0.0765 dm3
Artikelnr.	02620016
Gewicht (bruto, KG)	0,105
Gewicht PAP (KG)	0,000
Gewicht PVC (KG)	0,005
GTIN	4018754005086
Land van oorsprong	GERMANY
Regio van oorsprong	Nordrhein-Westfalen
WEEE/ElektroG	nicht ear-pflichtig
Douanetarief nr.	82042000
Verpakkingsstandaard	5
Gewicht (g)	21 g

Varianten.

Artikelnr.	Modelnr. (ERP)	Beschrijving	GTIN
02620016	460 A 1/4	3/8 " Dop Maat 1/4" L.32mm	4018754005086
02620020	460 A 5/16	3/8 " Dop Maat 5/16" L.32mm	4018754005093
02620024	460 A 3/8	3/8 " Dop Maat 3/8" L.38mm	4018754005109
02620028	460 A 7/16	3/8 " Dop Maat 7/16" L.38mm	4018754005116
02620032	460 A 1/2	3/8 " Dop Maat 1/2" L.44mm	4018754005123

GTIN-code.

